

Industrial Routing Switch

RFI-211-T3G

- ⌘ High performance and configurable
 - 11 ports including 3 gigabit ports
 - Powerful dual core CPU
 - Advanced WeOS layer 3 functionality
- ⌘ Designed for demanding Edge Network applications
 - Low power consumption DC supply
 - Highly configurable fault I/O contact
 - Ultra-robust IP40 aluminum housing
- ⌘ Robust for long service life
 - 430,000 hours MTBF to MIL-HDBK-217K
 - -40 to +70°C without ventilation holes
 - Industrial and trackside type tested
- ⌘ Unique future proof industrial networking solutions
 - Simple web configuration with professional CLI
 - Network IP Security and remote access
 - Multiple network resilience solutions



EN 50121-4
Railway Trackside

EN 61000-6-1
Residential Immunity

EN 61000-6-2
Industrial Immunity

EN 61000-6-3
Residential Emission

EN 61000-6-4
Industrial Emission

RedFox is a high performance layer 3 industrial Ethernet switch designed for high network traffic applications. Various port configurations are available that can be further customised with SFP transceivers RedFox is powered by the Westermo WeOS network operating system.

The RedFox is designed for use in heavy duty industrial applications in its robust aluminium housing. Its wide power range and I/O fault contact make it ideal for easy installation and monitoring in industrial applications.

Only industrial grade components are used which gives the RedFox an MTBF of 430,000 hours and ensures a long service life. A wide operating temperature range -40 to +70°C (-40 to +158°F) can be achieved with no moving parts or cooling holes in the case. RedFox has been tested both by Westermo and external test houses to meet many EMC, isolation, vibration and shock standards, all to the highest levels suitable for heavy industrial environments and rail trackside application.

WeOS has been developed by Westermo to allow us to offer cross platform and future proof solutions. WeOS can deliver unique IP security functionality for this class of product, for instance a Multiport DMZ can be constructed by utilising the internal port based firewall function. Remote secure access to a network can be provided using encrypted VPNs. For more WeOS functionality please see the WeOS datasheet.

Ordering Information

Art.no	Description
3641-4110	RFI-211-T3G, Industrial routing switch
3125-0001	PS-30, Power supply, DIN mounted (Accessories)

Specifications RFI-211-T3G

Dimensional drawing

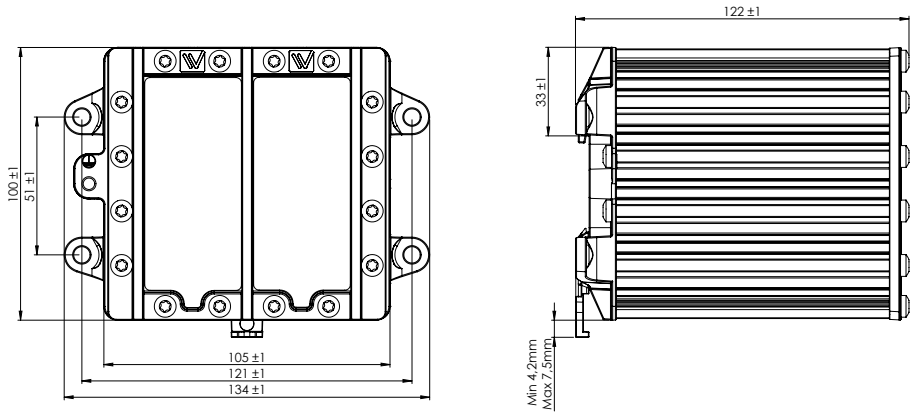

Dimension 134 × 100 × 122 mm (5.25 × 3.93 × 4.80 in)

Weight 1.5 kg

Degree of protection IP40

Power

Operating voltage	16 to 60 VDC
Rated current	0.43 (0.60*) A @ 20 VDC 0.19 (0.25*) A @ 48 VDC

*With 500mA USB load

Interfaces

Console	1 × USB Micro-B connector
USB	1 × USB 2.0 host interface
Digital I/O	1 × 4-ports detachable screw terminal
Ethernet	3 × 10/100/1000 Mbit/s, Ethernet TX, RJ-45 8 × 10/100 Mbit/s, Ethernet TX, RJ-45

Temperature

Operating	-40 to +70°C (-40 to +158°F)
Storage & Transport	-50 to +85°C (-58 to +185°F)
Maximum surface temperature	135°C (275°F) (temperature class T4)

Agency approvals and standards compliance

EMC	EN 50121-4, Railway applications – Electromagnetic compatibility – Emission and immunity of the signalling and telecommunications apparatus
	EN 61000-6-1, Electromagnetic compatibility – Immunity for residential, commercial and light-industrial environments
	EN 61000-6-2, Electromagnetic compatibility – Immunity for industrial environments
	EN 61000-6-3, Electromagnetic compatibility – Emission standards for residential, commercial and light industrial environments
	EN 61000-6-4, Electromagnetic compatibility – Emission standard for industrial environments
Safety	UL/IEC/EN 60950-1, IT equipment
Marine	DNV GL rules for classification – Ships and offshore units